



*Manufacturers of Process
Controls and Instrumentation*

Instruction Manual

Model: *RCI-400-XXX*

Function: *Remote Control Signal Interface*

- Communication:
- XXX=SER: RS-232/485*
 - XXX=MDM Modem Dial-Up*
 - XXX=FSK: Leased Line*
 - XXX=RF9: 900 Mhz Wireless*
 - XXX=NET: Ethernet (TCP/IP)*

Input: 4 "Dry" Contacts and 8 Analog Inputs

Output: 4 Form 'C' Contacts and 8 Analog Outputs

Power: 117VAC, 50/60Hz

24 VDC

Serial #: _____

(If special or required)

For Technical Assistance And Questions Call
USA: (231) 788-2900 CANADA: (905) 660-5336

Restocking Policy

All product returned to Pribusin Inc. in prime condition (not damaged, scratched or defaced in any way) within seven (7) months from the original date of shipment is subject to a 50% restocking charge. All product must be accompanied by a Return Authorization number (RA number) which must be obtained from Pribusin Inc. prior to returning any product.

After seven (7) months from the original date of shipment, products cannot be returned for restocking.

Custom designed products, modified products or all non-standard products may not be returned for restocking.

Warranty Policy

Pribusin Inc. warrants equipment of its own manufacture to be free from defects in material and workmanship, under normal conditions of use and service, and will replace any component found to be defective, on its return to Pribusin Inc., transportation charges prepaid, within one year of its original purchase. Pribusin Inc. will extend the same warranty protection on equipment, peripherals and accessories which is extended to Pribusin Inc. by the original manufacturer. Pribusin Inc. also assumes noliability, expressed or implied, beyond its obligation to prelace any component involved. Such warranty is in lieu of all other warranties, expressed or implied.

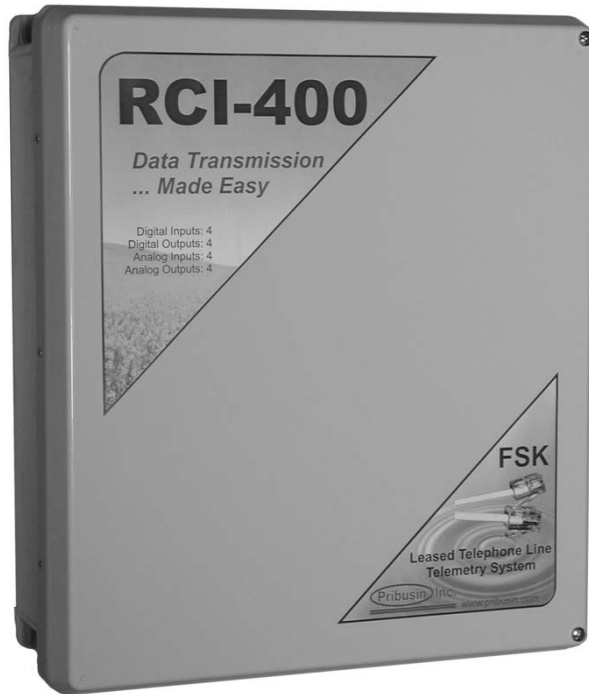

Standard Features:

Bi-directional Communication using Ethernet/Internet
Point-to-Point or Point-to-Multipoint Operation
4 Dry Contacts and 4 Analog Inputs
4 'C' Relay Contacts and 4 Analog Outputs
No Calibration Required
Microprocessor Controlled for High Accuracy
Power: 117 VAC 50/60 Hz (Optional 24 VDC)
High Noise Rejection

Function:

The RCI-400-NET is a bi-directional ethernet communication system that exchanges the status of 4 dry contact inputs and 4 analog inputs between a host and one or more remote unit(s). A basic system consists of A) one host unit and one remote unit **OR** B) one host unit several remote units.

In system A), the host unit continually interrogates the remote unit and exchanges its inputs and outputs. Inputs from the host are sent to the outputs of the remote while inputs from the remote are sent to the outputs of the host.

In system B), several remote units are connected to one host unit and can exchange data from their inputs and outputs with the host inputs and outputs. The total I/O count on all remote units may not exceed the I/O count of the host unit.

Connection:

Units are connected via a standard 10/100 Ethernet. Regular RJ45 jacks make for easy installation.

Specifications:

Transmission Medium: 10/100 Ethernet, RJ-45 connection
Operating Temperature: -20 Deg.C. to +50 Deg.C.
Relay Contacts: 10A 1/8Hp @ 125VAC
6A 1/8Hp @ 277VAC
Power: 117 VAC, 60/50 Hz
(24VDC Available)
Enclosure: NEMA4X

RCI-400-NET

Enclosures & Dimensions:

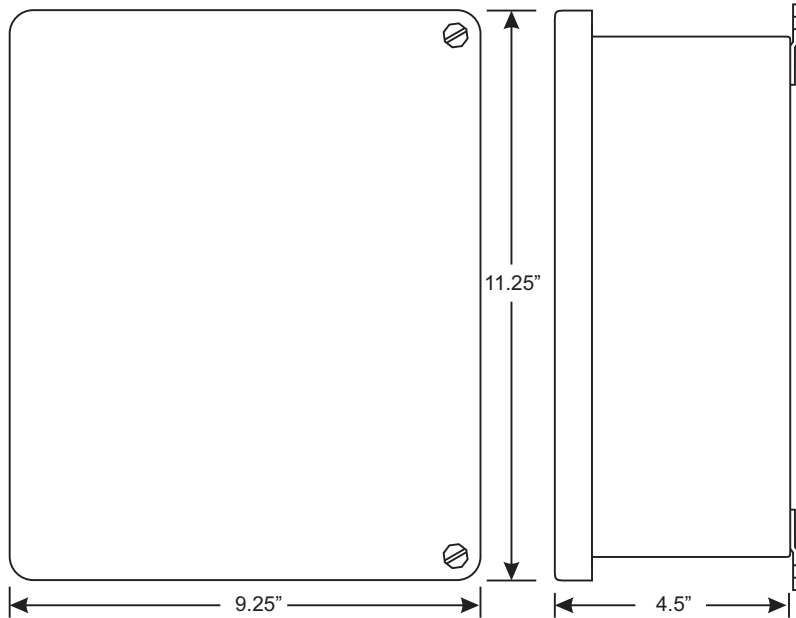

Connection:

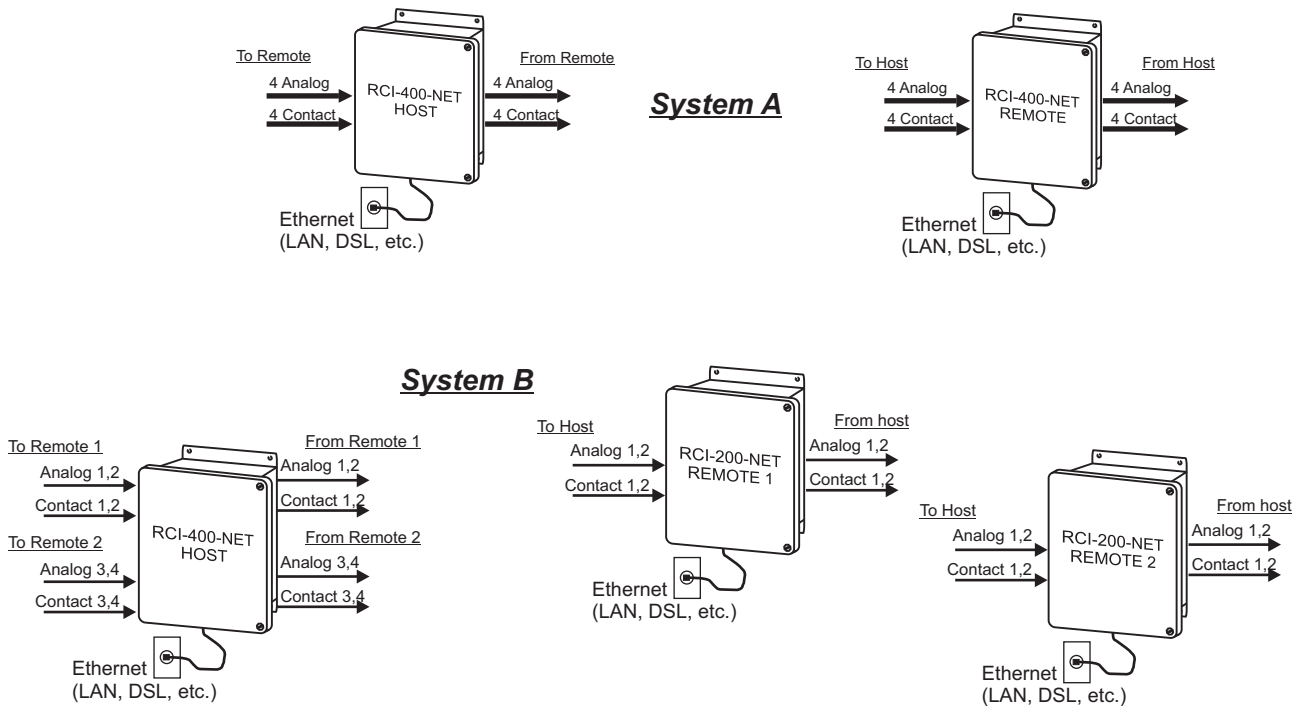

Manufactured By:

Pribusin Inc.

www.pribusin.com
info@pribusin.com

USA:

Pribusin Inc.
743 Marquette Avenue
Muskegon, MI 49442
Ph: (231) 788-2900
Fx: (231) 788-2929



CANADA:

Pribusin Inc.
101 Freshway Dr. Unit 57
Concord, Ontario, L4K 1R9
Ph: (905) 660-5336
Fx: (905) 660-4068

Mounting Holes
10

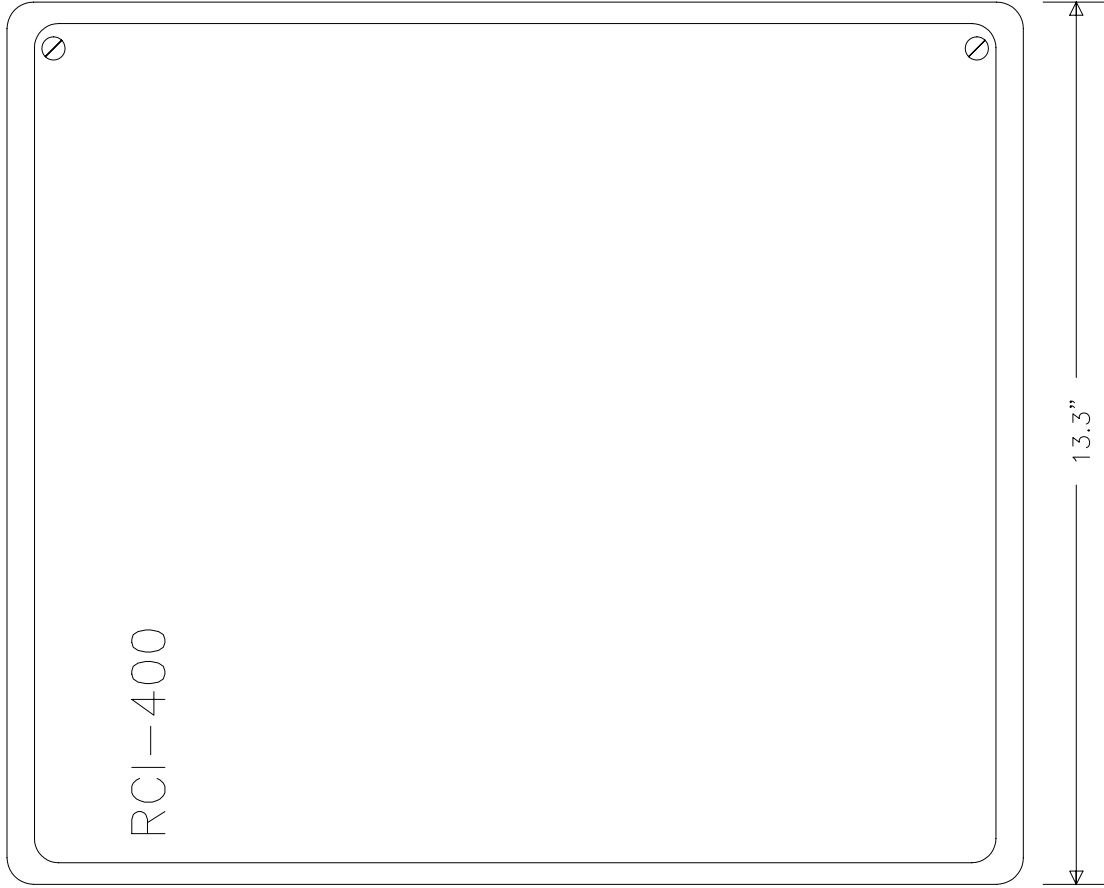

Pribusin Inc. ©	
CHKD: V.B	DATE: MAY14/10
RCI-400 ENCLOSURE DIMENSION	
DWG. NO.:	108126
REV. A	

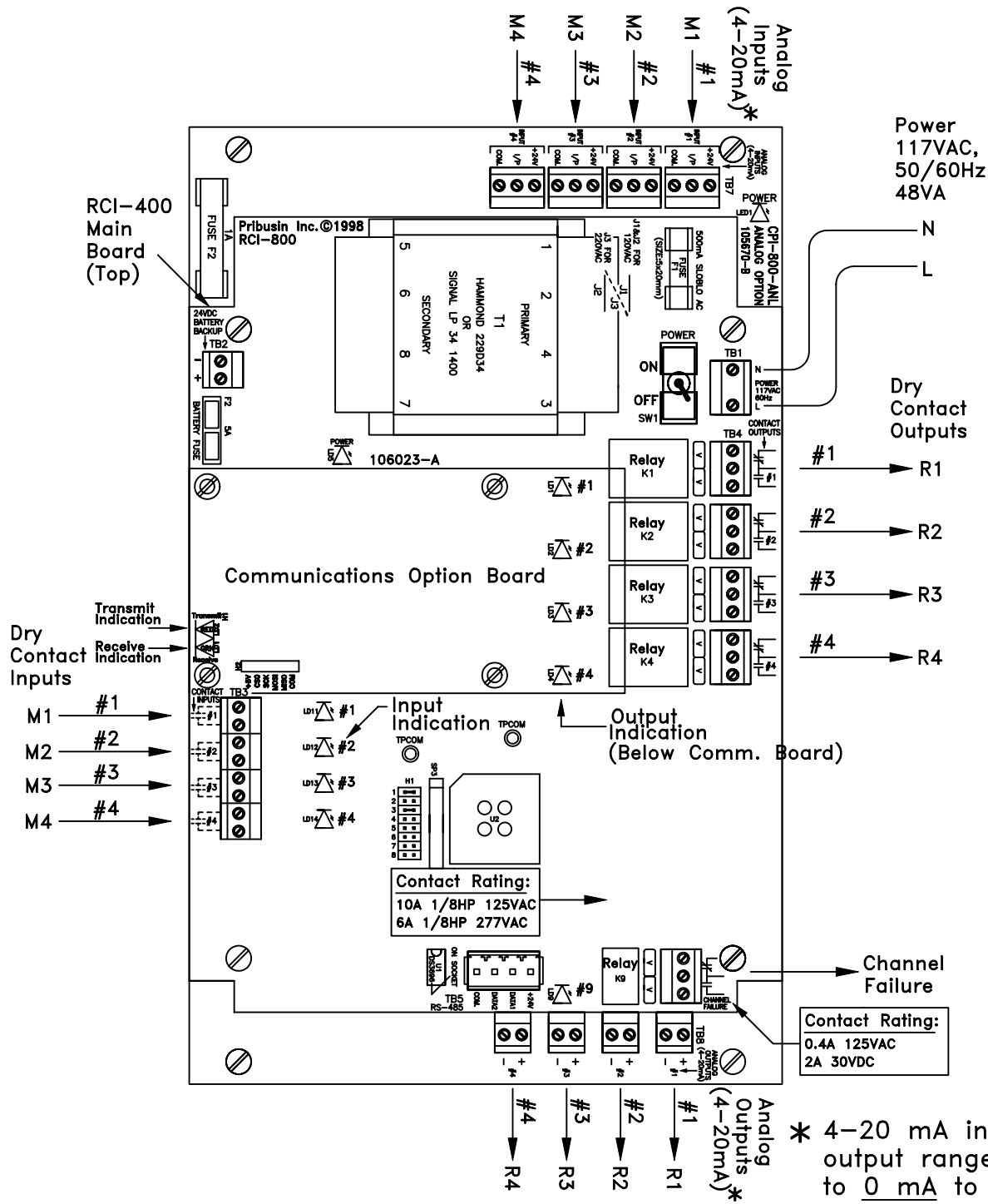

Pribusin Inc. ©		
CHKD:	DATE: Jan 4/01	DRN: MG
Model: RCI-400-XXX Remote Control Signal Interface Connection Diagram		
DWG. NO.:	106411	REV. A

RCI-400 Connections:

The RCI-400 is the main board of an RCI-400-XXX Telemetry system. It provides the input and output signal connections as well as the power supply for the unit. The RCI-400 consists of two circuit boards: a main controller board with four contact inputs and four contact outputs and below it an analog input/output board with four analog inputs and four analog outputs. A separate communications board is added to the RCI-400 to allow it to communicate with other units. This communications board may have its own configuration that is in a separate section of this manual. The following configuration applies only to the RCI-400 board and is common to all communications interfaces.

AC Power & Fuse:

The RCI-400 is typically powered from 120VAC and protected by a 500mA SLOBLO fuse. It can be wired for 240VAC operation by removing (desoldering) power jumpers J1 & J2 and installing (soldering) jumper J3.

When changing the RCI-400 to 240VAC power make sure to change the fuse to half of its value, 250mA. This is important since at 240VAC the RCI-400 requires only half the current as if it were powered from 120VAC. Proper protection is only achieved by reducing the fuse value as mentioned above.

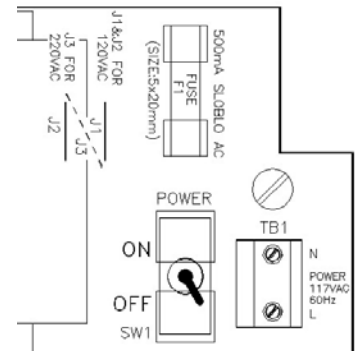

DC Power & Battery Backup:

The RCI-400 may also be powered from a 24VDC source which could be a battery or a DC power supply. The 24VDC power input is polarity protected with a fuse to prevent damage to the RCI-400 by inadvertent reverse polarity. A DC fuse provision is also provided if this power option is utilized. Insert a 5A automotive type blade fuse into the Battery Fuse socket.

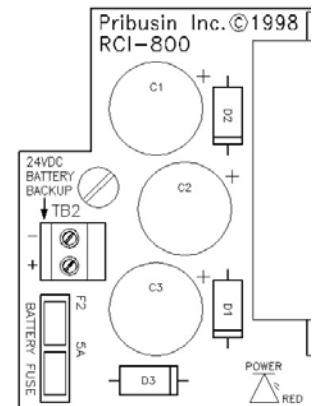

A separate 1A fuse protects the 24VDC power output to field transmitters (+24V terminal on analog inputs). This fuse is located on the analog input output board (bottom board).

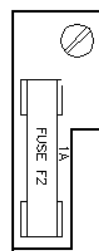

Inputs:

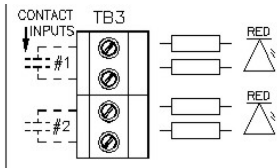

The RCI-400 has four dry contact inputs and four 0-20mA inputs. The dry contact inputs are excited with 24VDC and will source approximately 20mA when the contact is closed. A red LED lights up when a contact input is closed.

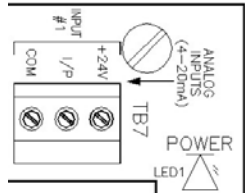

The analog inputs are configured as 0-20mA inputs and have a 250Ω input impedance. Each input terminal has three connections: +24V, I/P, COM. The +24V power output may be used to power field transmitters. Up to 125mA may be used to power a transmitter. The input signal is connected to I/P(+) and COM(-).

Analog inputs are connected to the RCI-400 in two fashions: 1) Normal (3-wire connection) or 2) two-wire connection. On a 3-wire connected input, an external power supply or the +24V power output terminal of the RCI provides power to the field transmitter. The field transmitter has a current source that provides the 4-20mA signal back to the RCI-400. If using the power supply of the RCI-400, the field transmitter may draw up to 125mA. A total of 1A is available to power up to 8 field transmitters.

On a 2-wire connected input, the field transmitter receives power from the RCI-400 and superimposes the signal onto the power return path. A maximum of 20mA will flow in such a connection. Make sure to consult the field transmitter manual to determine how to connect it to the RCI-400.

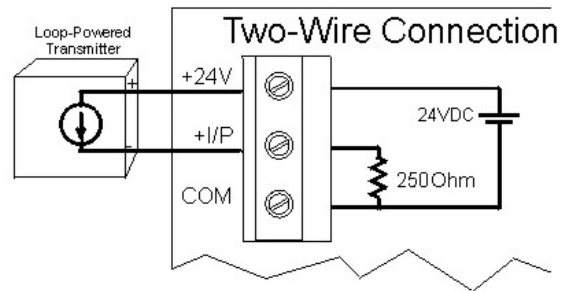
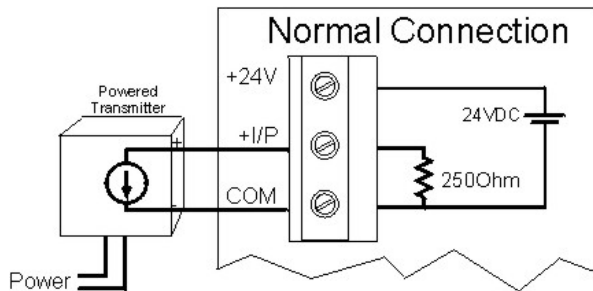

Outputs:

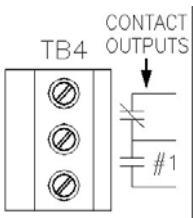

The RCI-400 has four form 'C' relay contact outputs and four 0-20mA analog outputs. The relay contacts are capable of switching 120VAC, 10A or 240VAC, 6A. An energy absorbing varistor is installed across each contact to limit switching transients. A ninth relay contact acts as a communications fail indicator. If no communication occurred within 60 seconds, this relay contact will energize. Upon re-established communication this relay will de-energize again.

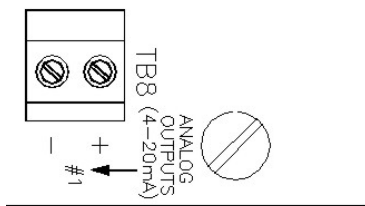

The four analog outputs are typically configured as 0-20mA outputs and can drive into a 1000Ω load each, provided that the power supply to the unit is not below 24VDC. The outputs are not isolated from each other or from the inputs. Care must be taken when connecting the outputs to different devices so that no inadvertent ground loops are established.

Output Calibration & Input Testing:

The outputs on the RCI-400 are factory calibrated and should not require any adjustments. To check the calibration of the outputs and relays use jumpers H1-7 & H1-8 as shown below to set them to known states. If an output should require some adjustment, the main circuit board has to be removed from the analog input/output board to gain access to the output calibration potentiometers. **With the power off**, remove the main circuit board and set it aside leaving it connected to the analog input/output board via the 4-conductor I/O cable. Turn the power on and insert jumper H1-8 on the main circuit board and turn the OUTPUT CALIB. trim pot for a particular output until that output reads 20mA. Turn the power off again before re-assembling the unit.

H1-7	H1-8	Function
OUT	OUT	Normal Operation
OUT	IN	Outputs=20mA, Relays=Energized
IN	OUT	Outputs=0mA, Relays=De-energized
IN	IN	Outputs=Inputs, Relays=Contact Inputs

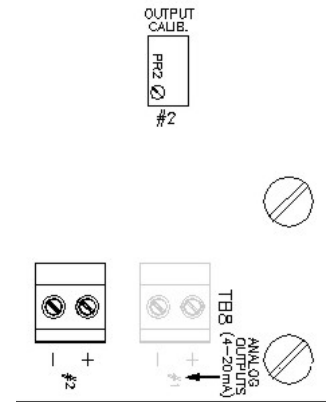

If both jumpers are IN the analog and contact inputs are passed straight through to the analog and relay outputs. This may help in troubleshooting input and output signals.

Make sure both jumpers are removed before resuming normal operation.

RCI-400 Configuration:

The RCI-400 requires no configuration other than for its communication fail operation. In the event of a communications failure on the communications board, the RCI-400 can be set up to take various actions on its outputs. This may be desirable in order to place connected devices into a safe operating mode. By default factory setting, all outputs remain at their last known state if a communications failure occurs.

H1-	Function	OUT	IN
1	Relay Fail Mode	No Change	See H1-2
2	Relay Fail Status	De-Energize	Energize
3	Output Fail Mode	No Change	See H1-4 ¹⁾
4	Output Fail Status	Ramp to 0%	Ramp to 100%
5	Output 0% Value ²⁾	0mA	4mA
6	Output Ramp Rate	10 seconds	60 seconds
7	I/O Calibration		
8	I/O Calibration		

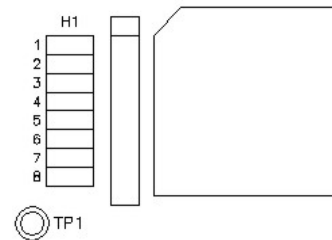

- 1) If H1-3=IN then all analog outputs will ramp to the either 0% or 100% depending on jumper H1-4. the outputs will change at a rate determined by the jumper H1-6.
- 2) The low end of the output value can be selected to be either 0mA or 4ma depending on jumper H1-5. This setting only applies to the output value during a fail condition when the outputs are selected to ramp to 0%. If jumper H1-5 is out, the outputs will ramp to 0mA, if it is in they will ramp to 4mA. The setting of this jumper does not affect the outputs during normal operation.

NET Communication Option:

The -NET communications option to the RCI series utilizes a TCP/IP connection to exchange the signal data between a host and its remote(s). There are two types of **Operating Topologies** that can be configured: 1) Point-to-Point and 2) Point-to-Multipoint.

The -NET communications option uses an Ethernet connection among all units. This can be a plant-wide LAN or internet WAN. In all cases, each RCI unit must be assigned a fixed IP address.

In a **Point-to-Point**

topology one host communicates with one remote. The two exchange all their signals with one another. The remote is configured as remote #1 even though it is the only remote in the system.

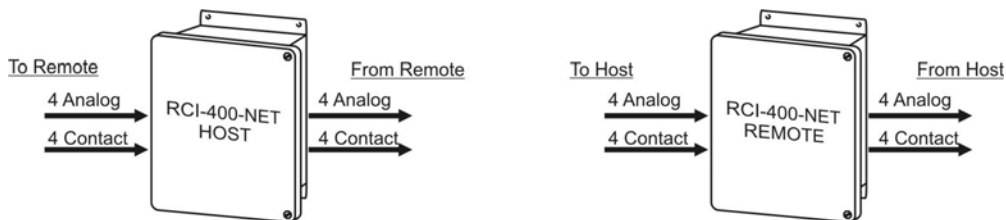

In a **Host-to-Multipoint**

topology one host communicates to several remotes. Each remote is assigned an address (1,2,3, etc.) so that the host may distinguish between them. There may at most be as many remotes as there are inputs & outputs on the host.

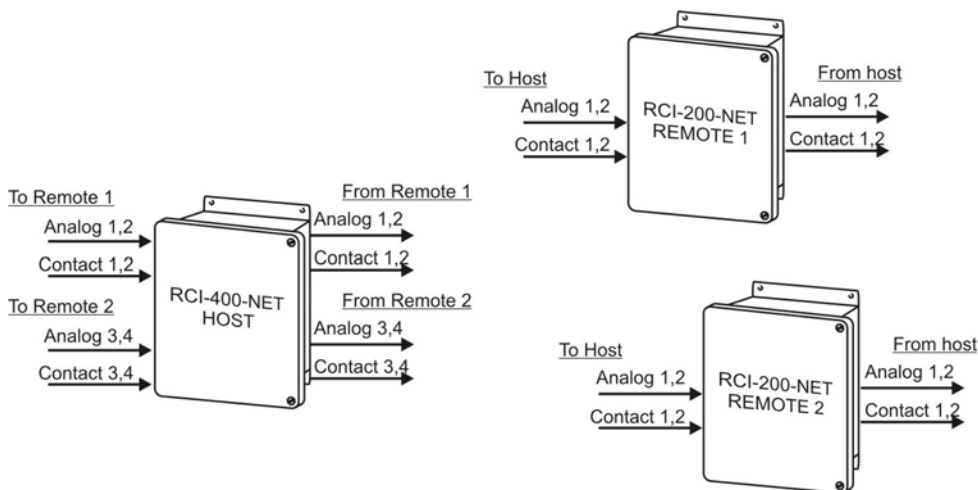

For example, an RCI-400 system, having four analog/contact inputs and outputs, may be set up to communicate with two remotes each having two analog/contact input and output. In this case all **#1 & #2 inputs and outputs on the host correspond to the #1 & #2 inputs and outputs on remote #1** and all **#3 & #4 inputs and outputs on the host correspond to the #1 & #2 inputs and outputs on remote #2**. The second analog/contact input and output on each of the two remotes would be unused.

RCI-MDM Configuration Software

In order to configure the RCI-XXX-NET units you need to download and install the free RCI NET CONFIGURATION utility from <http://www.pribusin.com/ethernet-tcp-ip.htm> .

General

FIRMWARE It is very important that you select the correct firmware for your specific RCI-NET unit. You can find this information by reading the top label of the microchip in your RCI-NET. The last letter is the firmware code.

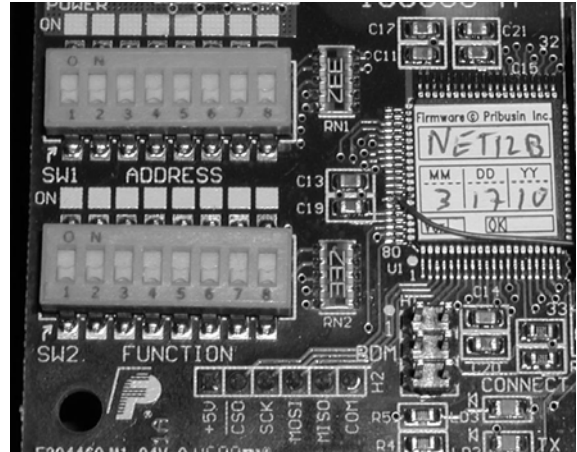
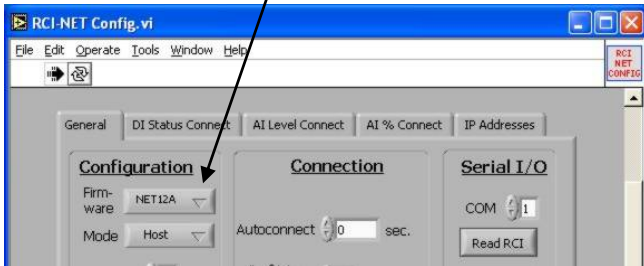

MODE This defines if the unit is a host or a remote. If it is a remote it further identifies the remote address. This is especially important in multi-remote systems.

Allowable values:

0 = Host, 1 thru 8 = Remote1 thru Remote8

REMOTES Number of remotes in the system. In a multi-remote system, this tells the host how many remotes it has to call when it initiates a call.

Allowable values: 1 thru 8

HOST CHANNELS Number of channels to be used on the host. All channels of all remotes in any system must add up to the number of channels on the host.

Allowable values: 1 thru 8

REMOTES CHANNELx Number of channels to be used on this remote. Total channels of all remotes in a multi-remote system must not exceed HOST CHANNELS. (x=1..8)

Allowable values: 1 thru 8

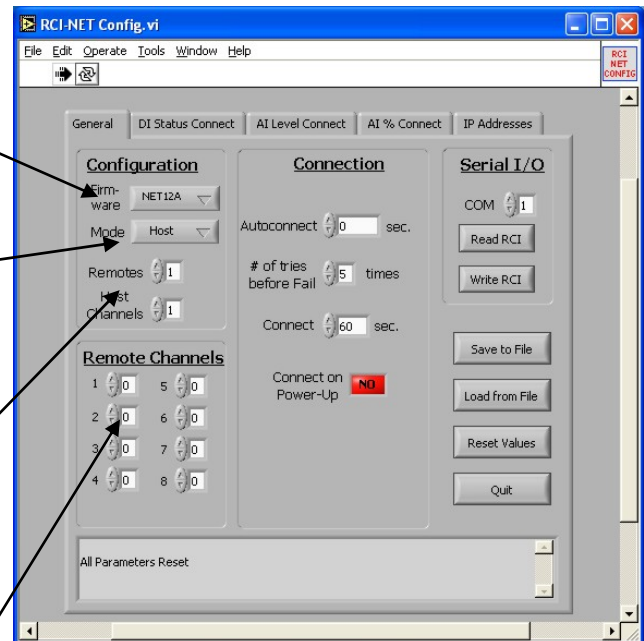

AUTOCONNECT The auto-connect time interval in seconds. If this parameter is set to 0 then the unit will NOT automatically initiate a call and will connect only when a DI or AI status changes (see below). If this parameter is set to a value greater than 0 then the unit will place a call automatically in this time interval.

Allowable values:

- 0 = no auto-connect
- 1-65535 auto-connect interval (sec.)

COMMUNICATION FAIL Number of connection attempts to be executed before the fail contact is activated.

Allowable values:

- 0 = continuous
- 1 thru 9 = attempts before fail signal

CONNECT Time interval, in seconds, the calling unit stays connected before it terminates the connection. While two units are connected they continually exchange their data. This is useful when an immediate confirmation is required after sending an action to the other unit.

Allowable values:

- 5-255 = connection duration in sec.
(note the 5 second minimum)

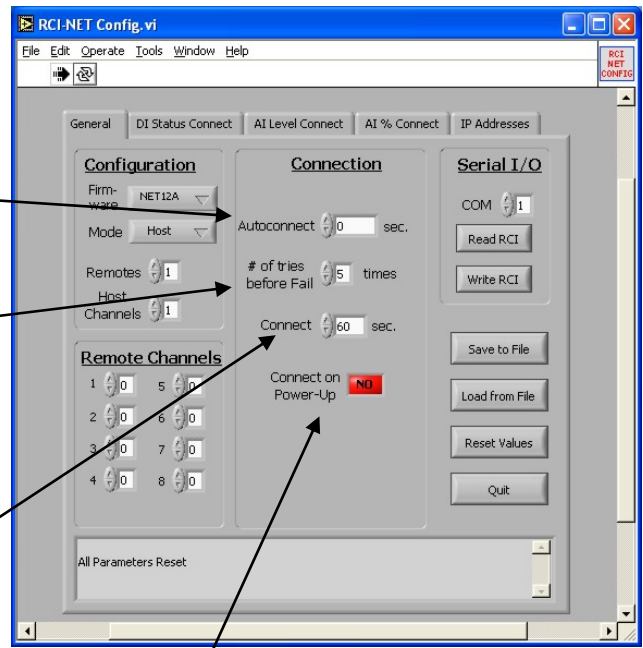

POWER-UP CONNECTION

This setting determines if the unit will initiate a connection at power-up. This is useful to re-establish proper input and output settings after a power failure.

Allowable values:

- NO = no connection at power-up
- YES = connect after power-up

COM Select the COM Port to which the RCI-MDM is connected.

READ RCI Obtains configuration values that are stored in the RCI-MDM.

WRITE RCI Sends values to the RCI-MDM.

SAVE Allows you to save the configuration to a text file on your hard drive.

LOAD Allows you to load a configuration file from your hard drive.

RESET VALUES Resets all values to default settings.

QUIT Exits the Program.

DISPLAY Shows application processes, status and errors that occur.

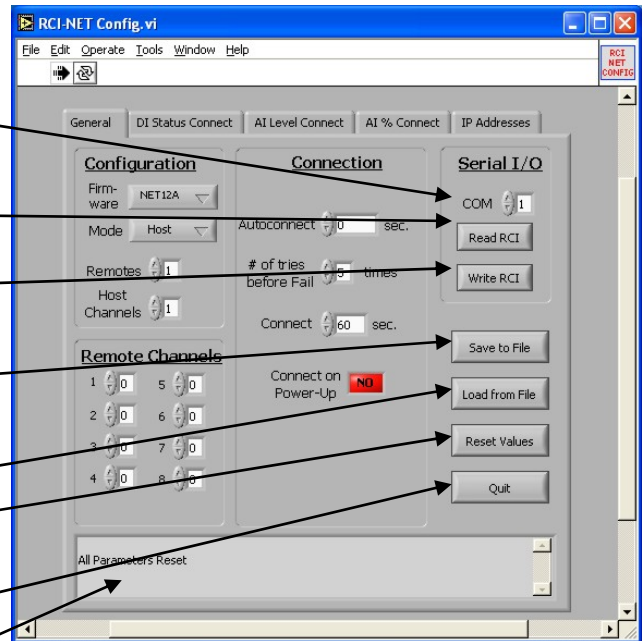

DI Status Connect

Determines whether or not a connection will be initiated when a Digital Input changes its status. If **NO** is selected for an input, no connection will be made if its status changes. However, if **YES** is selected, whenever that digital input switches from open-to-closed or closed-to-open, a connection will be made.

Currently only a host unit can be configured to make a connection based on a DI change.

Allowable values:

NO = no connection on status change

YES = connect on status change

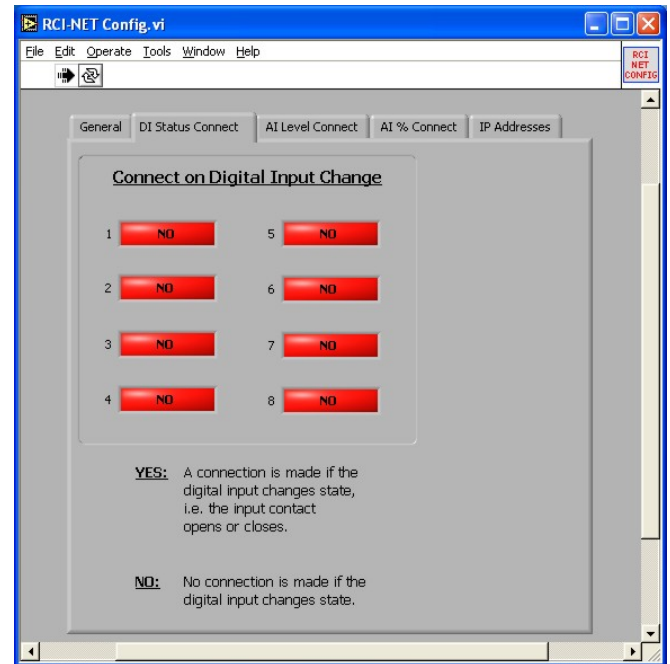

AI Level Connect

Determines if a HIGH/LOW level on Analog Input x (x=1,2,..8) causes a connection to be made. Currently only a host unit can be configured to make a connection based on a AI change.

A HIGH level occurs when the input value rises above this parameter. When the input level drops below 2% below this parameter the level is considered NORMAL and another connection will be made automatically.

A LOW level occurs when the input value falls below this parameter. When the input level rises above 2% above this parameter the level is considered NORMAL and another connection will be made automatically.

Allowable values:

- 0 = no connect on HIGH and/or LOW level
- 1-65535 = connect on HIGH and/or LOW level and connect when HIGH and/or LOW level returns to NORMAL

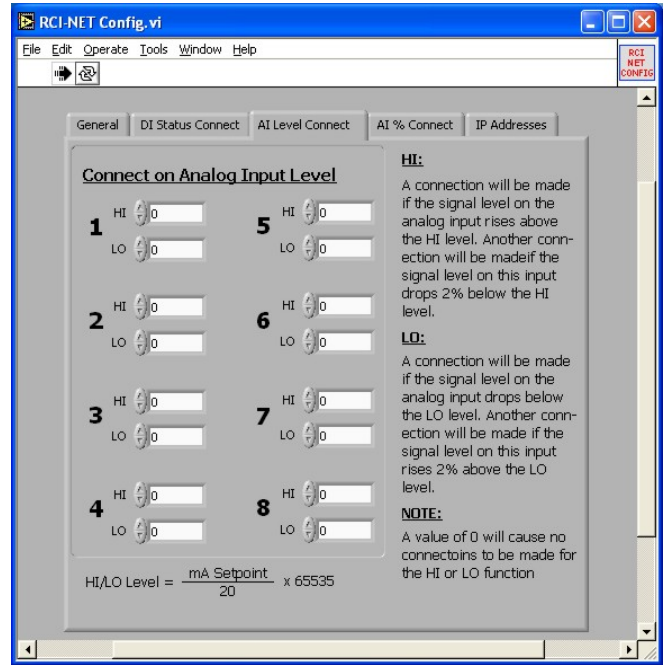

The parameter is calculated as follows:

$$\left[\text{PARAMETER} = \frac{\text{SETPOINT}(mA) - 4mA}{16mA} \times 65535 \right]$$

(where SETPOINT is between 4-20mA)

AI % Connect

Determines if a specific amount of change on Analog Input x (x=1,2,..8) causes a connection to be made. Currently only a host unit can be configured to make a connection based on a DI change.

The amount of change required before a connection is made is expressed as a percentage of full-scale signal. Be aware that a full-scale signal is from 0-20mA. Hence a 5% change would be 1mA. A call will be placed if the input signal either rises or falls more than the specified percentage compared to the signal level at the last connection.

Allowable values:

- 0 = no connection for percent change
- 1-50 = connect on % change from NORMAL

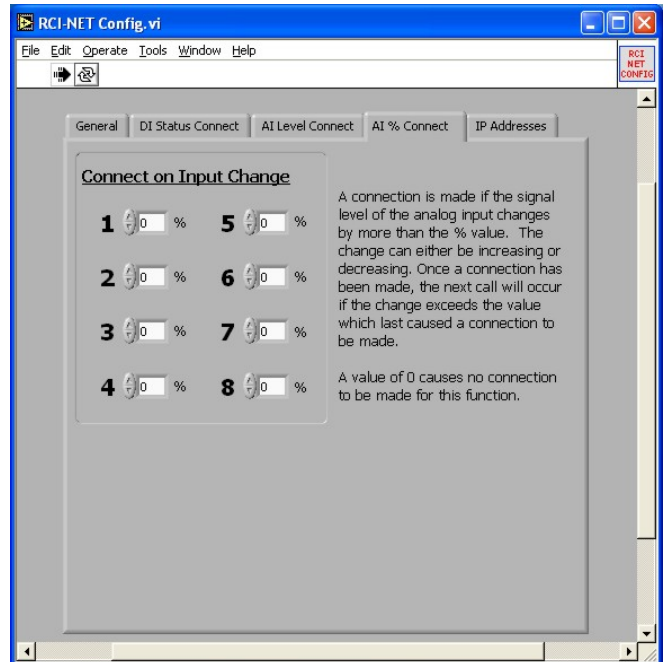

IP Addresses

GATEWAY The gateway IP address

NET MASK The subnet mask

HOST The IP address for the HOST

REMOTE1 The IP address for REMOTE 1.

:
:
:

REMOTE8 The phone number for REMOTE 8.

TCP PORT The TCP port used to communicate over TCP/IP

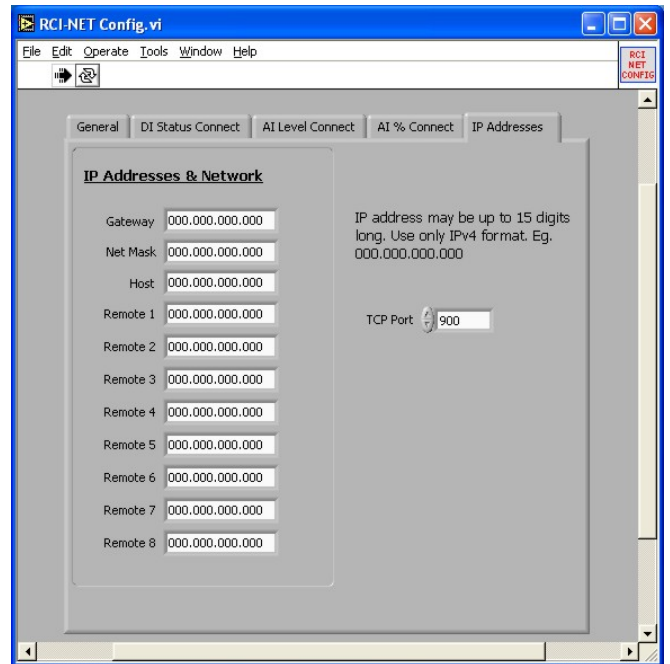

Downloading & Uploading Configuration Data:

To download the internal configuration data of the RCI-XXX-NET or upload new configuration data it must first be place in PROGRAMM mode.

1. Turn the power switch OFF.

2. Locate SW1 (upper DIP switch) on the communication board (raised off the main RCI board)

3. Switch only SW1-8 to the ON position. Make sure all other switches are OFF.

4. Connect the serial cable to the RS-232 connector on the modem board and to your serial port on your computer.

5. Make sure you have your RCI Net Configuration software running on your computer.

6. Turn the power switch back on and wait at least 5 seconds.

You can now download and upload configuration data as many times as necessary until the unit is configured properly. We suggest that you download the configuration data again after you have uploaded it and verify all settings to make sure that the RCI-XXX-NET accepted it properly.

Upon completion **turn the power switch OFF again**, return SW1-8 to the OFF position, disconnect the serial cable and finally **turn the power switch back on**.

