



*Manufacturers of Process
Controls and Instrumentation*

Instruction Manual

Model: *RCI-400-XXX*

Function: *Remote Control Signal Interface*

Communication: *XXX=SER: RS-232/485*
 XXX=MDM Modem Dial-Up
 XXX=FSK: Leased Line
 XXX=RF9: 900 Mhz Wireless
 XXX=RF2: 2.4 Ghz Wireless

Input: 4 "Dry" Contacts and 4 Analog Inputs

Output: 4 Form 'C' Contacts and 4 Analog Outputs

Power: 117VAC, 50/60Hz
 24 VDC

Serial #: _____

(If special or required)

For Technical Assistance And Questions Call
USA: (231) 788-2900 CANADA: (905) 660-5336

Restocking Policy

All product returned to Pribusin Inc. in prime condition (not damaged, scratched or defaced in any way) within seven (7) months from the original date of shipment is subject to a 50% restocking charge. All product must be accompanied by a Return Authorization number (RA number) which must be obtained from Pribusin Inc. prior to returning any product.

After seven (7) months from the original date of shipment, products cannot be returned for restocking.

Custom designed products, modified products or all non-standard products may not be returned for restocking.

Warranty Policy

Pribusin Inc. warrants equipment of its own manufacture to be free from defects in material and workmanship, under normal conditions of use and service, and will replace any component found to be defective, on its return to Pribusin Inc., transportation charges prepaid, within one year of its original purchase. Pribusin Inc. will extend the same warranty protection on equipment, peripherals and accessories which is extended to Pribusin Inc. by the original manufacturer. Pribusin Inc. also assumes noliability, expressed or implied, beyond its obligation to prelace any component involved. Such warranty is in lieu of all other warranties, expressed or implied.

Remote Control Signal Interface With 2.4GHz Radio Frequency Link



Standard Features:

- Bi-directional Communication using License-free 2.4GHz Radio Band
- Spread-Spectrum Radio Technology Provides Reliable Communication
- Re-Transmission & Error Correction Algorithms ensure Accurate Data Transmission
- 4 Dry Contact and 4 Analog Inputs
- 4 'C' Relay Contacts and 4 Analog Outputs
- Point-to-Point or Host-to-Multipoint Topologies
- No Calibration Required
- Microprocessor Controlled for High Accuracy
- Power: 117 VAC 50/60 Hz (Optional 24 VDC)
- High Noise Rejection
- CSA and NRTL Approved (LR51078)

Function:

The RCI-400-RF2 is a bi-directional data communication system that exchanges the status of 4 dry contact inputs and 4 analog inputs between a master and one or more remote units. A basic system consists of one master station and one remote station each with 4 dry contact and 4 analog inputs and 4 'C' relay contact and analog outputs. All signals are bi-directional so that data may be read from the remote station and sent to it.

The license-free spread-spectrum radio technology allows small systems to be set up with very little effort and at low cost. The technology ensures high communication reliability even in RF-intensive environments.

All units are sold with a ¼ wave omnidirectional whip antenna. Other antennas, such as directional Yagi or Patch antennas, are sold separately.

Options:

- A: 24VDC Power
- B: 240VAC Power
- N12: NEMA 12 Enclosure
- R: Remote Radio (Radio is in separate enclosure and mounts close to antenna to prevent signal loss for long cable runs)

Specifications:

- Media: 2.4GHz Spread-Spectrum Radio
- Range: up to 1500ft indoors with omnidirectional antenna
up to 12 miles line-of-sight with directional antenna
- Protocol: MODBUS ASCII
- Speed: 9600 BAUD
- Radio Power Output: 500mW max.
- Operating Temperature: -4°F to +140°F (-20°C to +60°C)
- Relay Contacts: 10A 1/8Hp @ 125VAC
6A 1/8Hp @ 277VAC
- Power: 117 VAC, 60/50 Hz, 24VDC Available
- Enclosure: NEMA4X (NEMA12 available as an option)
- Approvals: ETL 3118354:
UL 60950-1-2007; CSA-C22.2 No. 60950-1-07

RCI-400-RF2

Enclosures & Dimensions:

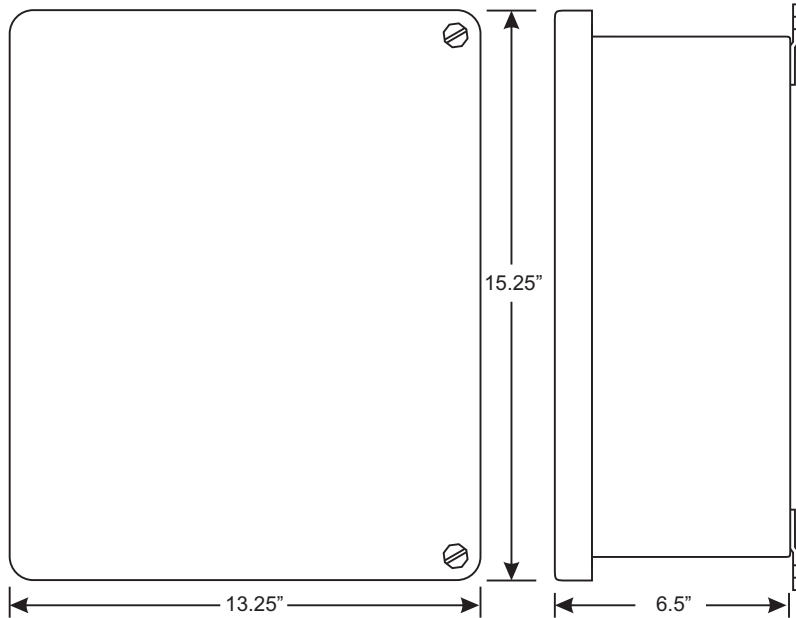

Connection:

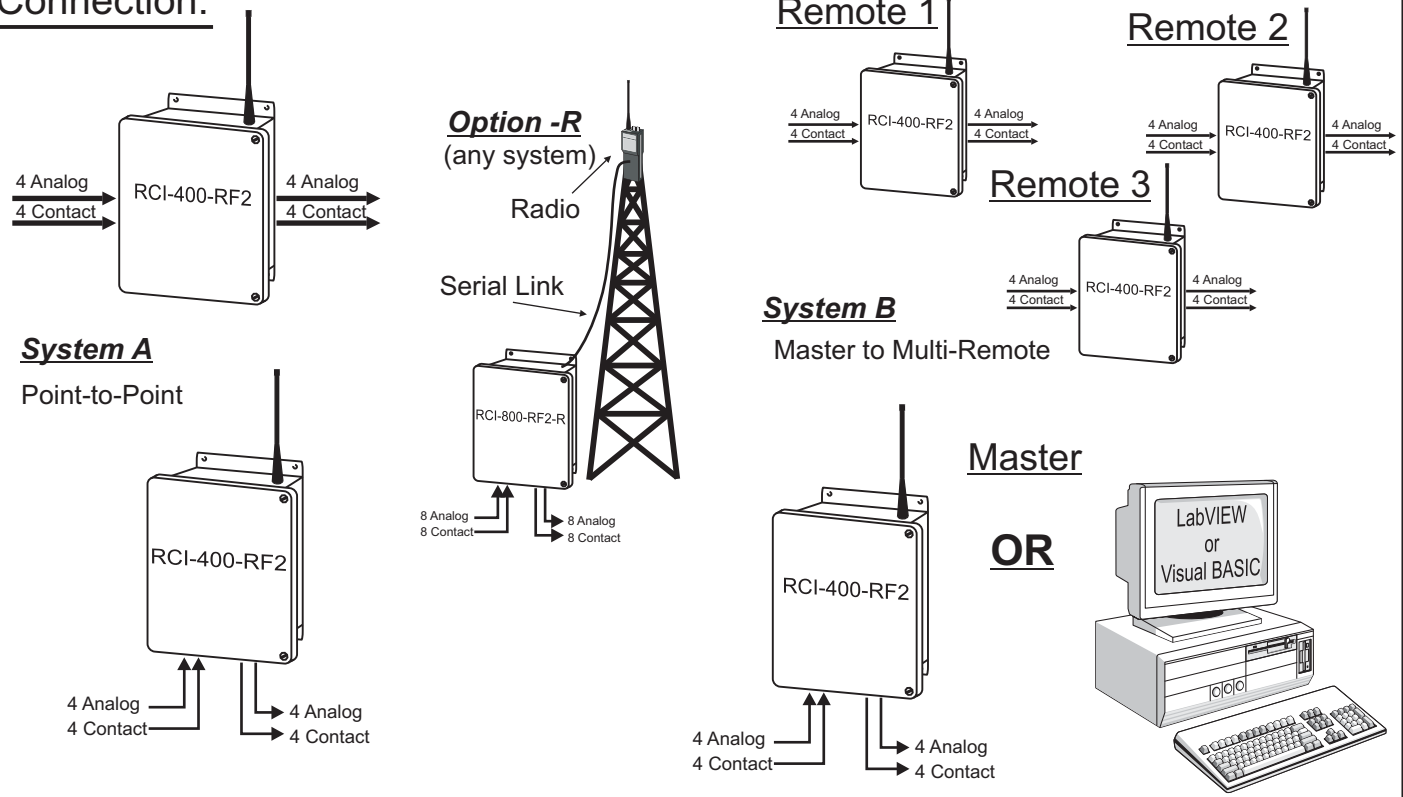

Manufactured By:



www.pribusin.com
info@pribusin.com

USA:

Pribusin Inc.
743 Marquette Ave.
Muskegon, MI 49442
Ph: (231) 788-2900
Fx: (231) 788-2929



CANADA:

Pribusin Inc.
101 Freshway Dr. Unit 57
Concord, Ontario, L4K 1R9
Ph: (905) 660-5336
Fx: (905) 660-4068

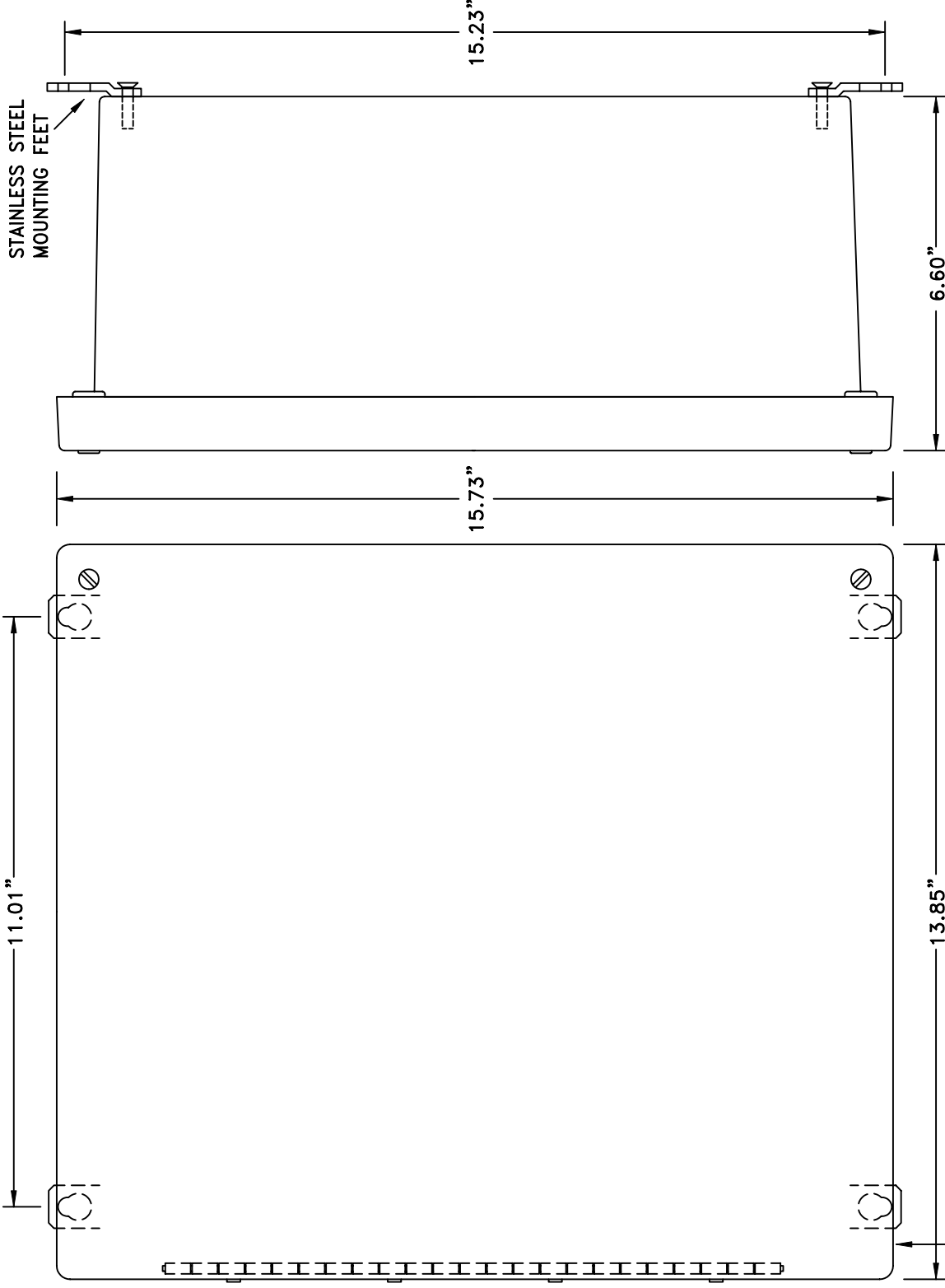

NEMA 4X AM SERIES FIBERGLASS ENCLOSURE
 WITH STAINLESS STEEL HINGE
 AND SCREW COVER

Pribusin Inc. ©

CHKD:	DATE: OCT. 02/01	DRN: KS
NEMA 4X AM SERIES FIBERGLASS ENCLOSURE (BOX SIZE: 14" x 12" x 6")		
DWG. NO.:	106470-6	REV. A

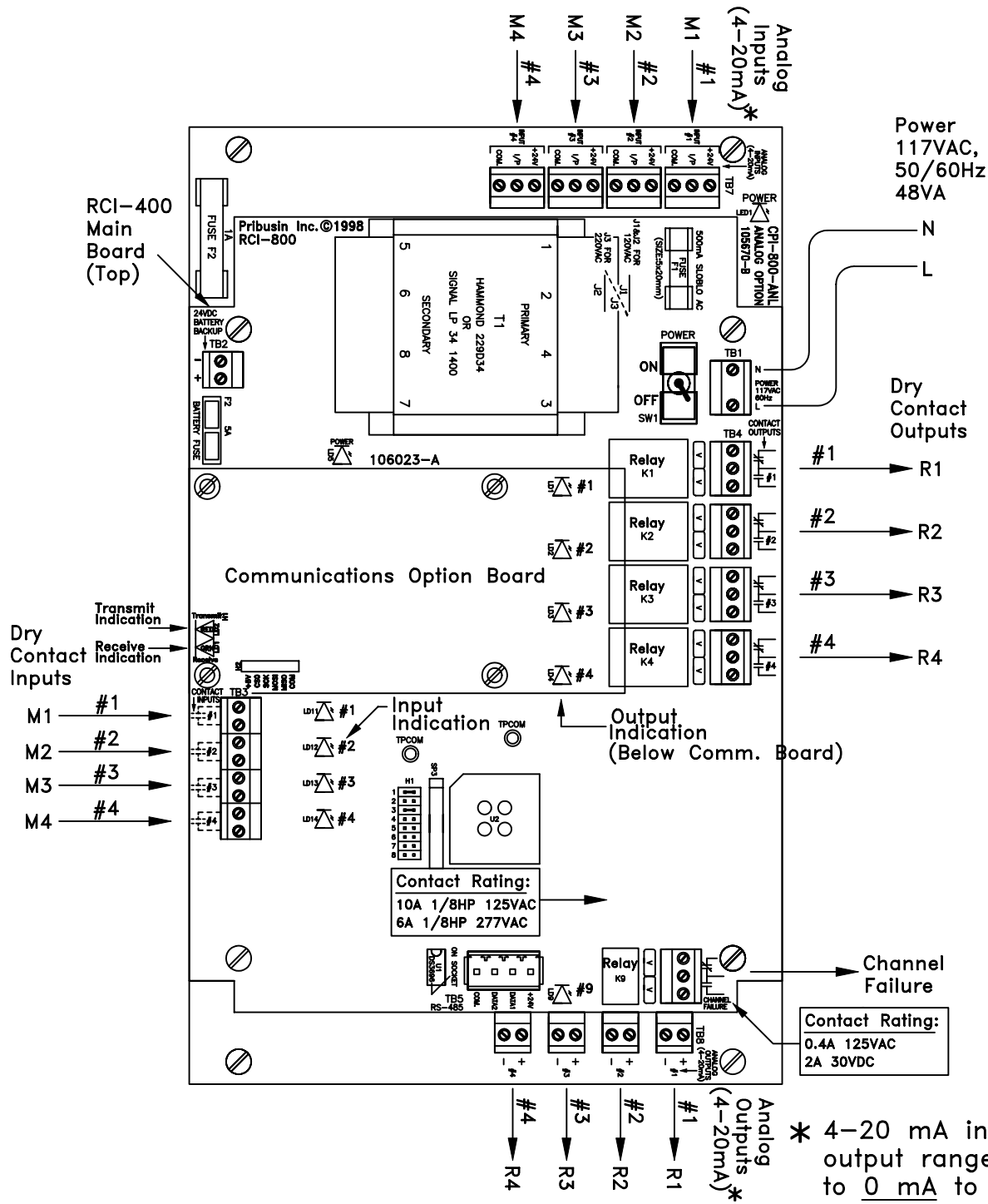

Pribusin Inc. ©		
CHKD:	DATE: Jan 4/01	DRN: MG
Model: RCI-400-XXX Remote Control Signal Interface Connection Diagram		
DWG. NO.:	106411	REV. A

RCI-400 Connections:

The RCI-400 is the main board of an RCI-400-XXX Telemetry system. It provides the input and output signal connections as well as the power supply for the unit. The RCI-400 consists of two circuit boards: a main controller board with four contact inputs and four contact outputs and below it an analog input/output board with four analog inputs and four analog outputs. A separate communications board is added to the RCI-400 to allow it to communicate with other units. This communications board may have its own configuration that is in a separate section of this manual. The following configuration applies only to the RCI-400 board and is common to all communications interfaces.

AC Power & Fuse:

The RCI-400 is typically powered from 120VAC and protected by a 500mA SLOBLO fuse. It can be wired for 240VAC operation by removing (desoldering) power jumpers J1 & J2 and installing (soldering) jumper J3.

When changing the RCI-400 to 240VAC power make sure to change the fuse to half of its value, 250mA. This is important since at 240VAC the RCI-400 requires only half the current as if it were powered from 120VAC. Proper protection is only achieved by reducing the fuse value as mentioned above.

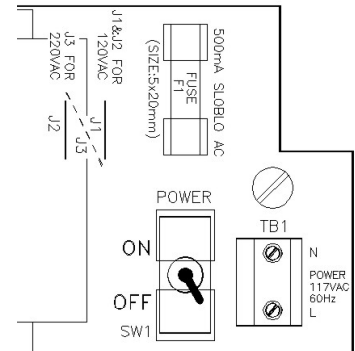

DC Power & Battery Backup:

The RCI-400 may also be powered from a 24VDC source which could be a battery or a DC power supply. The 24VDC power input is polarity protected with a fuse to prevent damage to the RCI-400 by inadvertent reverse polarity. A DC fuse provision is also provided if this power option is utilized. Insert a 5A automotive type blade fuse into the Battery Fuse socket.

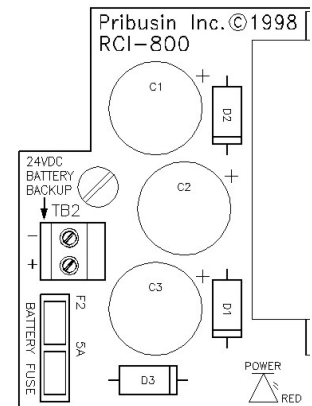

A separate 1A fuse protects the 24VDC power output to field transmitters (+24V terminal on analog inputs). This fuse is located on the analog input output board (bottom board).

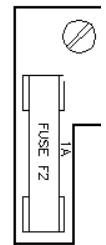

Inputs:

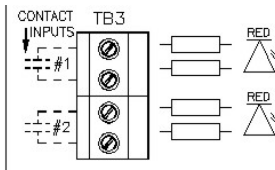

The RCI-400 has four dry contact inputs and four 0-20mA inputs. The dry contact inputs are excited with 24VDC and will source approximately 20mA when the contact is closed. A red LED lights up when a contact input is closed.

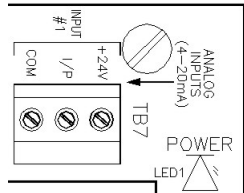

The analog inputs are configured as 0-20mA inputs and have a 250Ω input impedance. Each input terminal has three connections: +24V, I/P, COM. The +24V power output may be used to power field transmitters. Up to 125mA may be used to power a transmitter. The input signal is connected to I/P(+) and COM(-).

Analog inputs are connected to the RCI-400 in two fashions: 1) Normal (3-wire connection) or 2) two-wire connection. On a 3-wire connected input, an external power supply or the +24V power output terminal of the RCI provides power to the field transmitter. The field transmitter has a current source that provides the 4-20mA signal back to the RCI-400. If using the power supply of the RCI-400, the field transmitter may draw up to 125mA. A total of 1A is available to power up to 8 field transmitters.

On a 2-wire connected input, the field transmitter receives power from the RCI-400 and superimposes the signal onto the power return path. A maximum of 20mA will flow in such a connection. Make sure to consult the field transmitter manual to determine how to connect it to the RCI-400.

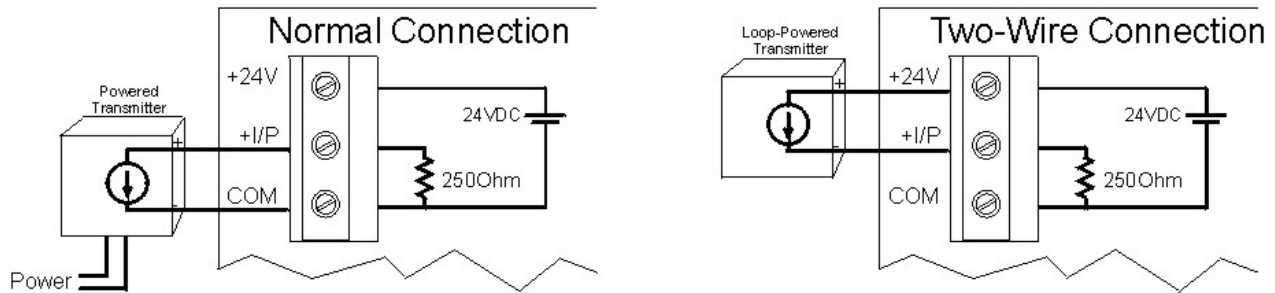

Outputs:

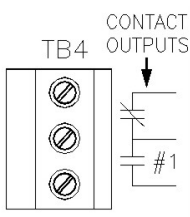

The RCI-400 has four form 'C' relay contact outputs and four 0-20mA analog outputs. The relay contacts are capable of switching 120VAC, 10A or 240VAC, 6A. An energy absorbing varistor is installed across each contact to limit switching transients. A fifth relay contact acts as a communications fail indicator. If no communication occurred within 60 seconds, this relay contact will energize. Upon re-established communication this relay will de-energize again.

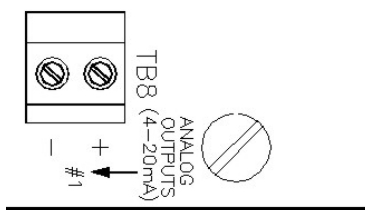

The four analog outputs are typically configured as 0-20mA outputs and can drive into a 1000Ω load each, provided that the power supply to the unit is not below 24VDC. The outputs are not isolated from each other or from the inputs. Care must be taken when connecting the outputs to different devices so that no inadvertent ground loops are established.

Output Calibration & Input Testing:

The outputs on the RCI-400 are factory calibrated and should not require any adjustments. To check the calibration of the outputs and relays use jumpers H1-7 & H1-8 as shown below to set them to known states. If an output should require some adjustment, the main circuit board has to be removed from the analog input/output board to gain access to the output calibration potentiometers. **With the power off**, remove the main circuit board and set it aside leaving it connected to the analog input/output board via the 4-conductor I/O cable. Turn the power on and insert jumper H1-8 on the main circuit board and turn the OUTPUT CALIB. trim pot for a particular output until that output reads 20mA. Turn the power off again before re-assembling the unit.

H1-7	H1-8	Function
OUT	OUT	Normal Operation
OUT	IN	Outputs=20mA, Relays=Energized
IN	OUT	Outputs=0mA, Relays=De-energized
IN	IN	Outputs=Inputs, Relays=Contact Inputs

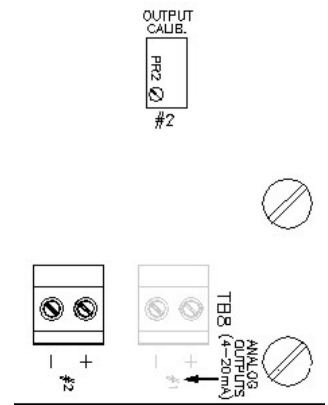

If both jumpers are IN the analog and contact inputs are passed straight through to the analog and relay outputs. This may help in troubleshooting input and output signals.

Make sure both jumpers are removed before resuming normal operation.

RCI-400 Configuration:

The RCI-400 requires no configuration other than for its communication fail operation. In the event of a communications failure on the communications board, the RCI-400 can be set up to take various actions on its outputs. This may be desirable in order to place connected devices into a safe operating mode. By default factory setting, all outputs remain at their last known state if a communications failure occurs.

H1-	Function	OUT	IN
1	Relay Fail Mode	No Change	See H1-2
2	Relay Fail Status	De-Energize	Energize
3	Output Fail Mode	No Change	See H1-4 ¹⁾
4	Output Fail Status	Ramp to 0%	Ramp to 100%
5	Output 0% Value ²⁾	0mA	4mA
6	Output Ramp Rate	10 seconds	60 seconds
7	I/O Calibration		
8	I/O Calibration		

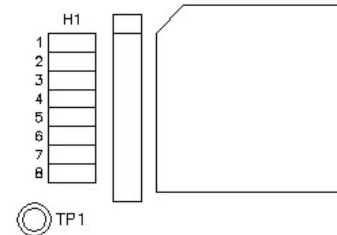

- 1) If H1-3=IN then all analog outputs will ramp to the either 0% or 100% depending on jumper H1-4. the outputs will change at a rate determined by the jumper H1-6.
- 2) The low end of the output value can be selected to be either 0mA or 4ma depending on jumper H1-5. This setting only applies to the output value during a fail condition when the outputs are selected to ramp to 0%. If jumper H1-5 is out, the outputs will ramp to 0mA, if it is in they will ramp to 4mA. The setting of this jumper does not affect the outputs during normal operation.

RF2 Communication Option:

The –RF2 communications option to the RCI series utilizes license-free spread spectrum radio frequency transmissions to exchange the signal data between a host and its remote(s). There are two types of **Topologies** that can be configured: 1) Point-to-Point and 2) Host-to-Multipoint.

In a **Point-to-Point** topology one host communicates with one remote. The two exchange all their signals with one another. The remote is configured as remote #1 even though it is the only remote in the system.

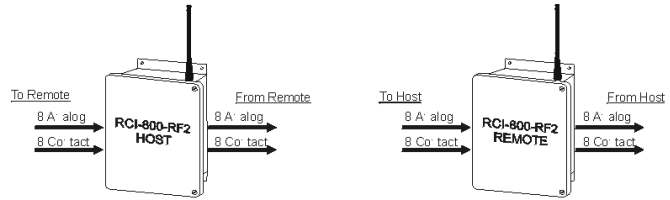

In a **Host-to-Multipoint** topology one host communicates to several remotes. Each remote is assigned an address (1,2,3, etc.) so that the host may distinguish between them. There may at most be as many remotes as there are inputs & outputs on the host.

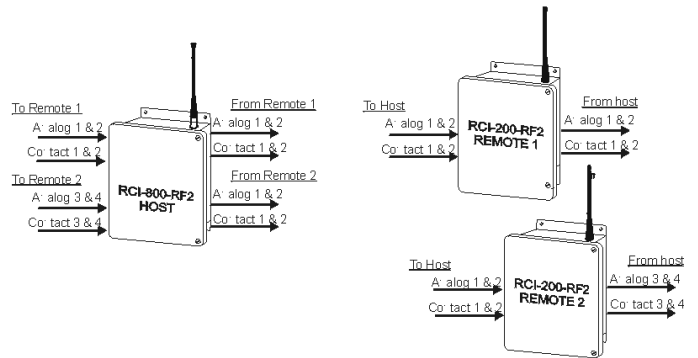

An RCI-400 configured as a host may communicate in one of the following system setups:

- a) 1 RCI-400 remote
- b) 2 RCI-400 remotes configured as 2-channel remotes
- c) 4 RCI-200 remotes each having 1 channel

Host (4-Channel)	Remote #1 (4-Channel)
DI 1-4	DO 1-4
DO 1-4	DI 1-4
AI 1-4	AO 1-4
AO 1-4	AI 1-4

Host (4-Channel)	Remote #1 (1-Channel)	Remote #2 (1-Channel)	Remote #3 (1-Channel)	Remote #4 (1-Channel)
DI 1	DO 1			
DI 2		DO 1		
DI 3			DO 1	
DI 4				DO 1
DO 1	DI 1			
DO 2		DI 1		
DO 3			DI 1	
DO 4				DI 1
AI 1	AO 1			
AI 2		AO 1		
AI 3			AO 1	
AI 4				AO 1
AO 1	AI 1			
AO 2		AI 1		
AO 3			AI 1	
AO 4				AI 1

Host (4-Channel)	Remote #1 (2-Channel)	Remote #2 (2-Channel)
DI 1-2	DO 1-2	
DI 3-4		DO 1-2
DO 1-2	DI 1-2	
DO 3-4		DI 1-2
AI 1-2	AO 1-2	
AI 3-4		AO 1-2
AO 1-2	AI 1-2	
AO 3-4		AI 1-2

The above tables show the input-output relationships for the a), b) & c) system configurations

A **Network ID** allows multiple RF2 systems to co-exist within close proximity without interfering with one another. There are four Network ID's to choose from: A, B, C or D. The host and its remote(s) must be set to the same Network ID in order for them to communicate with each other.

All radio configurations are done via two banks of DIP switches. SW1 assigns the remote address from 1 to 100 using a binary encoding scheme. SW2 assigns the Topology, Network ID, Channel Numbers and Host/Remote Mode. The switches are located on the communications board just below the radio. They are a slanted rocker type that flips **up for OFF** and **down for ON**.

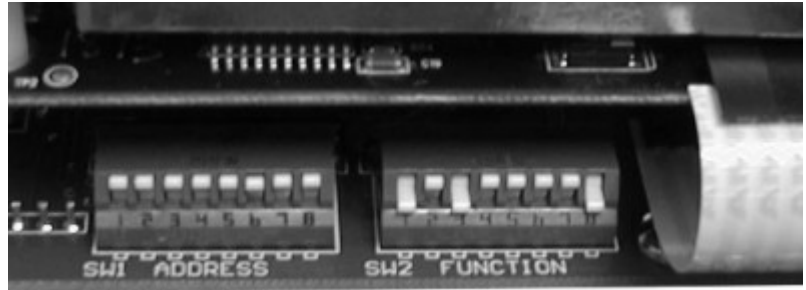

Radio Configuration:

The radio communication board has two banks of 8-position DIPswitches: SW1 and SW2. The function of these switches is slightly different for a host unit and a remote unit.

SW1-	HOST	REMOTE
1	# of Remotes	Remote Address
2	# of Remotes	Remote Address
3	# of Remotes	Remote Address
4		
5		
6		
7		
8		

SW2-	HOST	REMOTE
1	# of Channels on each Remote	# of Channels on this Remote
2	# of Channels on each Remote	# of Channels on this Remote
3	# of Channels on Host	
4	# of Channels on Host	
5	Network ID	Network ID
6	Network ID	Network ID
7	Operating Mode	Operating Mode
8	Host / Remote Select	Host / Remote Select

Network ID:

The Network ID is common to both the host and remote modes of operation. All hosts and remotes that are intended to communicate with each other must be set to the same Network ID. Four ID's are available: A, B, C, D. They are set as shown in the table.

SW2-5	SW2-6	Network ID
UP	UP	A
DOWN	UP	B
UP	DOWN	C
DOWN	DOWN	D

Host Configuration:

To make an RCI-400 operate as a host unit, make sure that SW2-8 is flipped down.

Next, set the **number of remotes** that the host is to communicate with using SW1-1, -2, -3. These switches are binary encoded as shown in the chart to the right.

SW1-1	SW1-2	SW1-3	# of Remotes
UP	UP	UP	1
DOWN	UP	UP	2
UP	DOWN	UP	3
DOWN	DOWN	UP	4

Next, set the **number of channels of each remote** using SW2-1, -2. One channel is considered 1 analog input/output plus 1 contact input/output. Hence an RCI-400 can have UP TO 4 channels. Remotes can only come in 1, 2, or 4 channel configurations

SW2-1	SW2-2	Channels on Remotes
UP	UP	1
DOWN	UP	2
UP	DOWN	4

Next, set the **number of channels of the host** using SW2-3, -4. An RCI-400 can have 4 channels. This is the number of channels that will be exchanged between the host and each remote. To match the total number of channels on all remotes, select the number of channels for the host.

SW2-3	SW2-4	Channels on Host
UP	UP	1
DOWN	UP	2
UP	DOWN	4

Remote Configuration:

To make an RCI-400 operate as a REMOTE unit, make sure that SW2-8 is flipped up.

Next, set the **remote address** using SW1-1, -2 & -3. Each remote in a system must have a unique address.

SW1-1	SW1-2	SW1-3	Remote Address
UP	UP	UP	1
DOWN	UP	UP	2
UP	DOWN	UP	3
DOWN	DOWN	UP	4

Next, set the **number of channels on this remote** using SW2-1, -2. One channel is considered 1 analog input/output plus 1 contact input/output. Hence an RCI-400 can have at most 4 channels.

SW2-1	SW2-2	Channels on Remote
UP	UP	1
DOWN	UP	2
DOWN	DOWN	4

Received Signal Strength Indicator (RSSI) :

The Signal Strength indicator is active in the Repeater Mode only.

The radio communications board has a signal strength indicator to show the level of the signal that was received from another radio. The indicator is a 10 segment LED bar graph as shown on the left. Each segment represents 10% of received signal. At least 50% of signal is required for proper operation of the radios.

The radios have an automatic power adjustment for optimal transmission. As a result the signal strength meter may never reach a full 10-segment count even when the two radios are right next to each other.

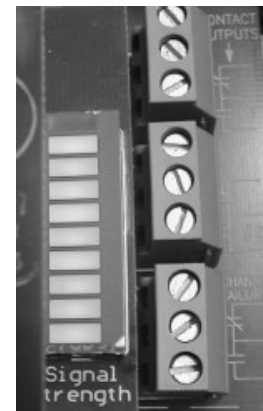

Cable & Antenna Selection & Installation:

The antenna is a very important component in a radio system. Make sure you consult the factory for proper antenna selection for your project. Cable leading from the radio to the antenna is just as important in establishing a reliable link. Special low-loss cable is available to ensure minimal signal losses in the cable leading to the antenna. This cable must be kept as short as possible. We recommend purchasing the cable from Pribusin Inc. to ensure a good match for the entire system. **Regular TV coaxial cable or even satellite dish coaxial cable will not work.** Even 'good' TV cables have enormous losses at the high frequency of this radio.

Line-of-Sight Installation:

To achieve maximum operational reliability, all antennas in a system must be installed in a line-of-sight fashion. This means that there are no obstructions between the host antenna and each of the remote antennas. This may require the antenna to be raised on a mast with some low-loss coaxial cable being installed. We recommend coaxial cables be kept as short as possible and not exceed 100ft.

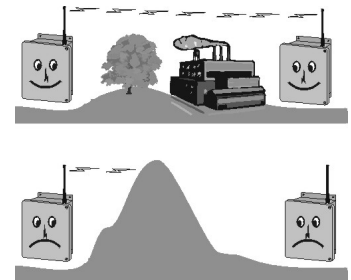

In some cases a direct line-of-sight may not be established, but if there are solid structures such as buildings, tanks etc. in the vicinity, the signal may reflect off these surfaces and reach an antenna via an indirect path. Such installations are not easy and are difficult to predict without on-site testing.

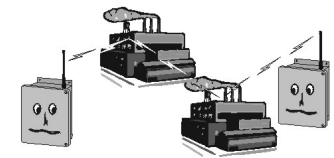

Antenna Polarization:

When installing antennas keep in mind that polarity matters. Align all antennas in the same direction. For example, if using omni-directional antennas, point them all straight up (or straight down). Do not point them in different directions or the range of the antennas will be greatly diminished to the point where no transmission may take place.

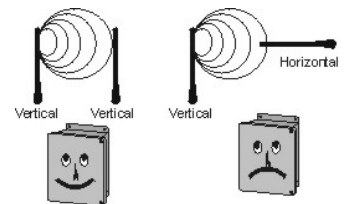

We suggest you consult Pribusin Inc. or your local Sales Rep. to discuss your antenna and cable requirements.